



- Brushless Electric Screwdrivers
- Torque Testers
- Screw Feeders
- Tool Supports



WARRANTY

Delta Regis products are warranted for one year from the date of purchase against defects in material and workmanship. In addition, DC premium brushless screwdrivers are warranted for two years and DC brushless motors are warranted for three years from the date of purchase against defects in material and workmanship. This warranty does not cover damage due to transportation, abuse, misuse, alteration, or improper service. Items subject to wear during normal use (such as tool cables, carbon brushes, driver bits, etc) are considered maintenance items and are not normally covered by this warranty, unless deemed to be defective upon our further evaluation. Our sole remedy is to repair or replace (at our discretion) any unit found to be defective due to defects in material or workmanship. It is the responsibility of the user to return any product thought to be defective, freight prepaid, to our warehouse for inspection and evaluation.

There is no warranty of merchantability or fitness of purpose. In no event will Delta Regis Tools, Inc. be liable for business interruptions, loss of profits, harm, injury, damage, personal injury, cost of delay, or any other special, indirect, incidental, or consequential losses, costs, or damages.

Efforts have been made to ensure the accuracy of the information and specifications in this catalog. Delta Regis Tools reserves the right to correct or change any specifications found herein without further notification.

Please contact us if you have any questions, concerns, or would like to discuss the details of an application. We are available to assist in any way that we can.

INFORMATION

WARRANTY	2
DRIVER SELECTION GUIDE & FEATURES	4-7
TORQUE CONVERSION TABLE	5

ELECTRIC SCREWDRIVERS & CONTROLLERS



12V MINI (0.07–3.08 in-lbs)	8
32V INLINE (0.2–26.0 in-lbs)	9
32V ANGLE (0.9–18.2 in-lbs)	10
32V CONTROLLERS, ACCESSORIES	11
40V INLINE (8.9–443 in-lbs)	12-14
40V ANGLE (8.9–195 in-lbs)	15
40V PISTOL (2.7–159 in-lbs)	16
40V CONTROLLERS, ACCESSORIES	17
COUNTING CONTROLLERS	18-19
SLOW START & I/O MODULES	20
120V INLINE / ANGLE (1.33–21.7 in-lbs)	21

SCREW FEEDERS, TORQUE TESTERS, ACCESSORIES



SCREW FEEDERS, 1.0–5.2 MM THREAD DIAMETER	22-23
MANUAL TORQUE DRIVERS, PRESET AND ADJUSTABLE	29
DRTQ TORQUE TESTERS, 1 IN-LB–100 FT-LBS	24-25
VACUUM PICKUP ATTACHMENT	30-31
SCREWDRIVER BITS AND BIT HOLDERS	31

TORQUE ARMS & TOOL SUPPORTS



TELESCOPIC REACTION ARMS, 12/30 NM	26
TOOL STAND AND TOOL BALANCERS	27
ERGO-SYS STAND, BALANCER AND ARM	28

BRUSHLESS SCREWDRIVERS MODEL OVERVIEW

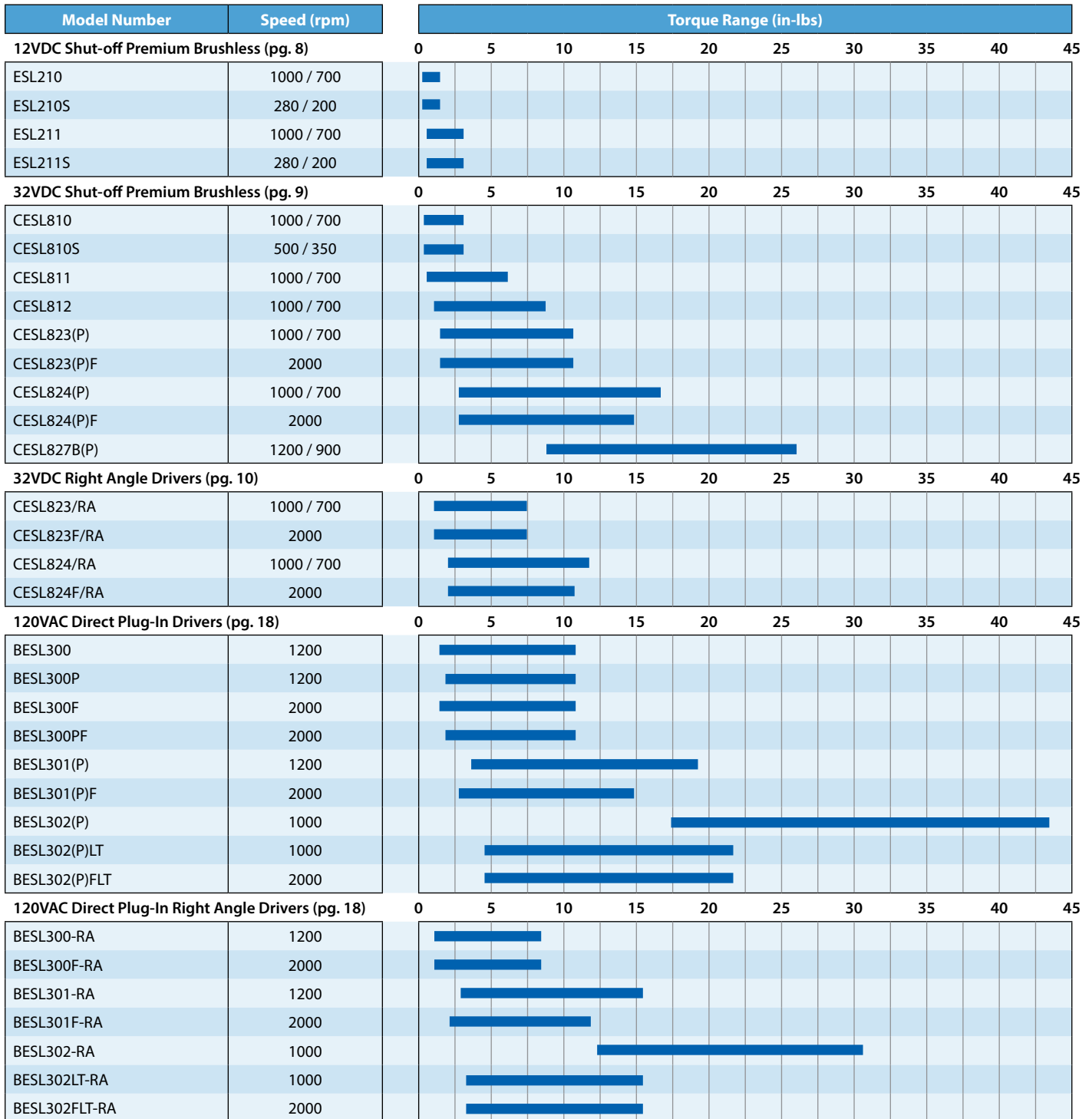

BRUSHLESS SCREWDRIVERS MODEL OVERVIEW

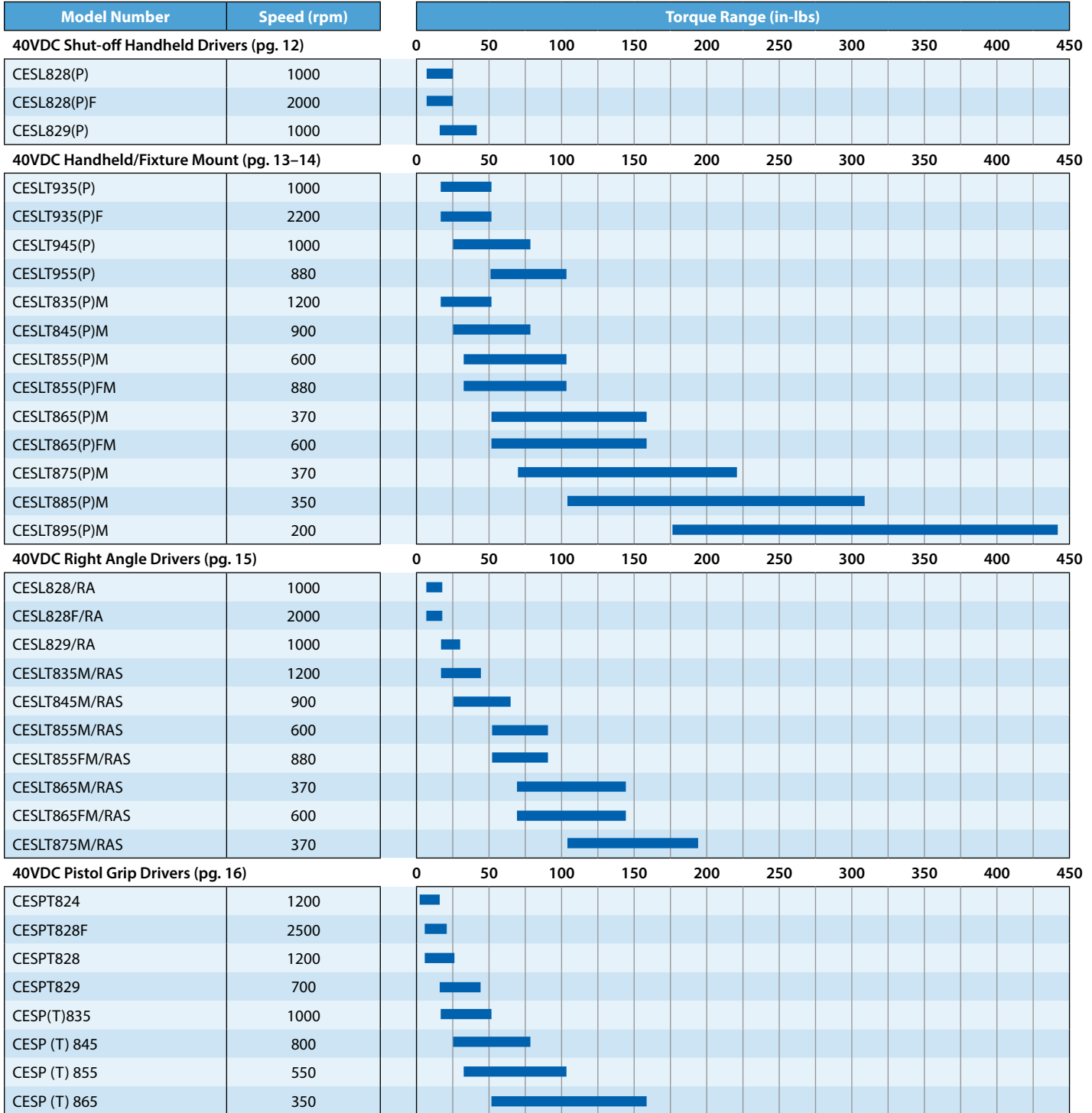

TORQUE CONVERSION TABLE
(row * cell = column)

	in-oz	in-lbs	ft-lbs	kgf-cm	Nm
in-oz	1	0.0625	0.0052	0.0720	0.0071
in-lbs	16	1	0.08333	1.152	0.1130
ft-lbs	192	12	1	13.826	1.1356
kgf-cm	13.89	0.868	0.0723	1	0.098
Nm	141.60	8.851	0.7376	10.197	1



SCREWDRIVER SELECTION GUIDE

Know Your Assembly Requirements

With the endless range of applications for installing threaded fasteners, proper selection of a screwdriver begins with knowing the details of the job that needs to be performed by the driver.

Torque — What is the required torque to properly install the fastener? This torque value is determined through the engineering and testing of the product being assembled and not something that we can provide for you. How critical is the final torque value?

Prevailing Torque — Is the fastener running down freely into a threaded hole, or is it self-tapping? Does the fastener have thread-locking compound or a locknut? Any prevailing torque must be lower than final torque.

Joint Type — Once the fastener initially seats, is there extended rotation of the screwdriver due to soft gaskets, spring washers, or other compression in the assembled joint?

Speed and Direction — Is the fastener installation speed restricted by materials (eg. plastics) or other design criteria? Will the screwdriver run primarily in the forward (CW) direction, or does the application require frequent switching between forward and reverse?

Duty Cycle — What is the estimated time to run-down a fastener? How many fasteners are installed per minute? How many hours will the tool be running per day? Is there prevailing torque during run-down?

Select The Appropriate Model

Based on the application's torque (and speed) requirements, the quick reference chart on the previous pages indicates possible choices in the Delta Regis product line. In many cases, you will find that several models of screwdrivers offer the required torque output. Try to select models where the required torque falls into the middle portion of the screwdriver's range. The chart is sub-divided by series of screwdrivers. If you require assistance in selecting the most appropriate model for your application, please feel free to contact us by phone or e-mail.

DC Premium Brushless (12V/32V/40V) — The DC brushless models offer the best performance for production applications. Clean running, maintenance-free brushless DC motors allow for higher duty cycles than brush motor tools. Premium low voltage DC drivers are available with ESD-safe housings and various control options. Standard controllers have Hi/Lo speed selection, optional controllers are available for slow start, I/O and counting with rundown verification. All brushless tools come with a precise shut-off clutch for excellent repeatability.

Our 40VDC High Torque models are an excellent upgrade from pneumatic tools in many applications. The clean brushless motor and consistent clutch overcome torque and environmental problems that can be associated with drivers running on compressed air.

SCREWDRIVER FEATURES

Torque Repeatability — Delta Regis Electric Drivers utilize precise clutches for repeatable performance. Each 32VDC and 120VAC driver is tested at mid-scale for repeatability within $\pm 3\%$. 12VDC and 40VDC drivers are tested for repeatability of $\pm 5\%$ or better. Please note that these are factory test values and that actual repeatability is joint dependent. It will vary based on factors such as joint type and consistency, lubrication, speed, operator input, and test equipment.

Suspension bail allows for hanging tool from tool balancer for improved ergonomics and tool life.

All models have a forward/reverse switch conveniently positioned for thumb operation.

12V, 32V, 40VDC screwdrivers are available with ESD-safe housings for assembling sensitive components.

Our drivers are designed with operator ergonomics in mind. Most models feature a cushioned grip for operator comfort.

Stepless external torque adjustment includes scale (0–8) for reference purposes (scale does not indicate actual torque value).



Quick change bit holder accepts industrial screwdriver bits:
ESL210–211: 4mm round bits
All other models: 1/4" hex power bits



A torque lock sleeve can be installed in place of the standard front housing nut to cover the torque adjustment and prevent accidental changes. 12VDC, 32VDC, and selected 40VDC brushless models include a torque lock sleeve.

ESL2 12VDC MINI BRUSHLESS, SHUT-OFF CLUTCH

0.07–3.08 in-lbs (0.01–0.343 Nm)

The Delta Regis ESL2 Series Miniature Shut-Off Screwdriver provides excellent low torque repeatability in a small package for precise installation of small screws. The screwdriver's brushless 12VDC motor ensures durability and low maintenance. Each tool includes a 2m cable for connecting to the required BECT200(N) Controller.

- Compact size designed for installing miniature fasteners. Ideal for assembly of cell phones and other small electronics
- Precise shut-off clutch provides excellent repeatability
- Torque range of 0.07–3.08 in-lbs (0.01–0.34 Nm)
- Low speed models available for sensitive applications
- ESD-safe tool housing is standard (non-ESD available)
- Lever start, top-mounted reverse button
- 12VDC brushless motor requires no maintenance
- Bit holder accepts 4mm round winged bits (2 included)
- Tool and controller are CE/RoHS compliant; Controller is ETL approved
- **Requires external power controller BECT200(N) sold separately**



Tool Includes



Model Number	Torque Range		Speed (RPM)	Length mm / in	Diameter mm / in	Weight g / lbs
	in-lbs	Nm				
ESL210-ESD	0.07–1.32	0.01–0.147	1000 / 700	165 / 6.5	23 / 0.9	170 / 0.4
ESL210S-ESD	0.07–1.32	0.01–0.147	280 / 200			
ESL211-ESD	0.44–3.08	0.05–0.343	1000 / 700			
ESL211S-ESD	0.44–3.08	0.05–0.343	280 / 200			

Controller*	Input	Output	Dimensions (L x W x H)	Weight (g / lbs)
BECT200(N)	100–240VAC, 1A	12/9VDC, 30W	100 x 50 x 35 mm / 3.9 x 2.0 x 1.4"	145 / 0.3

*Part number with North American cordset — Add suffix 'E' for EU cord, or suffix 'UK' for UK cord.

CESL8 32VDC PREMIUM BRUSHLESS, SHUT-OFF CLUTCH

The Delta Regis CESL8 Series Premium Brushless Screwdrivers provide the ultimate combination of ergonomics, precision, performance and environmental cleanliness to the installation of fasteners. The quiet, brushless DC motor does not create the carbon dust generated by the brushes in a conventional DC motor, and its low power consumption results in a tool that runs cooler, even under demanding applications.

The CESL8 Series 32VDC Brushless Screwdriver can be used with either the standard BECT620C/820(N) Hi/Lo Speed Controller or with our BECT832(N)-SSO-V4.0 FASTEN/COUNT/VERIFY Controller for applications requiring batch counting and input/output interface with external equipment.

- Precise torque control, low torque reaction
- Quiet, brushless DC motor means no carbon dust — 3 year motor warranty
- Compact body design results in exceptional maneuverability and operator comfort
- Less heat build-up and higher duty cycle capabilities than conventional brush motors
- Optional ESD-safe housing available
- CE/RoHS compliant

Tool Includes



0.2–26.0 in-lbs (0.02–2.94 Nm)

Model Number		Start Type	Torque Range		Speed (rpm)	Driver Bit Type	Length mm / in	Diameter mm / in	Weight g / lbs
Standard Housing	ESD Housing		in-lbs	Nm					
—	CESL810-ESD	Lever	0.2–3.1	0.02–0.35	1000 / 700	1/4" hex*	185 / 7.3	32 / 1.3	385 / 0.8
—	CESL810S-ESD				500 / 350				
—	CESL811-ESD		0.4–6.2	0.05–0.69	1000 / 700				
—	CESL812-ESD		0.9–8.7	0.1–0.98	1000 / 700				
—	CESL812S-ESD				280				
—	CESL812P-ESD	Push	1.8–8.7	0.2–9.8	1000 / 700				
CESL823	CESL823-ESD	Lever	1.3–10.5	0.15–1.18	1000 / 700	1/4" hex	245 / 9.6	36 / 1.4	520 / 1.1
CESL823P	CESL823P-ESD	Push							
CESL823F	CESL823F-ESD	Lever			2000				
CESL823PF	CESL823PF-ESD	Push							
CESL824	CESL824-ESD	Lever	2.6–16.5	0.29–1.86	1000 / 700	1/4" hex	245 / 9.6	36 / 1.4	520 / 1.1
CESL824S	CESL824S-ESD				500				
CESL824P	CESL824P-ESD	Push			1000 / 700				
CESL824PS	CESL824PS-ESD				500				
CESL824F	CESL824F-ESD	Lever	2.6–14.7	0.29–1.67	2000	1/4" hex	278 / 10.9	39.5 / 1.6	800 / 1.8
CESL824PF	CESL824PF-ESD	Push							
—	CESL827B-ESD**	Lever	8.7–26.0	0.98–2.94	1200 / 900	1/4" hex	278 / 10.9	39.5 / 1.6	800 / 1.8
—	CESL827BP-ESD**	Push							

*Drivers available with optional 4mm round (winged bit) bit holder — Add suffix '-4mm' to model number

**CESL827B(P)-ESD is for hard joint, non-prevailing torque applications below 20% duty cycle. Use 40V model CESL828 for more demanding requirements.



7370 Commercial Circle, Fort Pierce, FL 34951

772.465.4302

www.deltaregis.com

sales@deltaregis.com

32VDC RIGHT ANGLE DRIVERS

0.9–18.2 in-lbs (0.11–2.06 Nm)

Delta Regis 32VDC Right Angle Drivers provide access to fasteners located in areas that cannot be reached by a standard in-line tool.

- Precise torque control, low torque reaction
- Quiet, brushless DC motor means no carbon dust
- Less heat build-up and higher duty cycle capabilities than conventional brush motors
- Optional ESD-safe housing available
- CE/RoHS compliant



Tool Includes

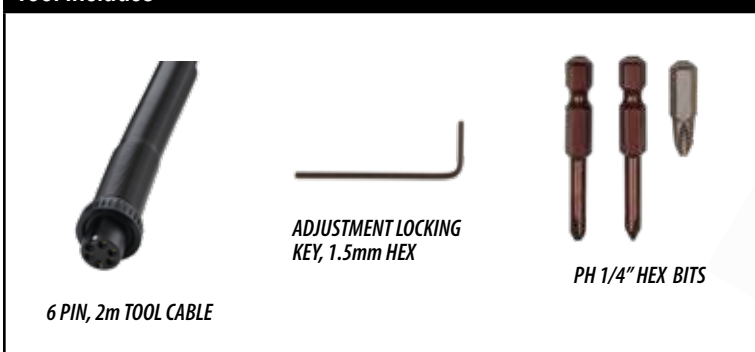

6 PIN, 2m TOOL CABLE

ADJUSTMENT LOCKING KEY, 1.5mm HEX

PH 1/4" HEX BITS

Model Number (Standard Housing)	Model Number (w/ ESD Housing)	Torque Range		Speed (rpm)	Weight g / lbs
		in-lbs	Nm		
CESL823/RA	CESL823-ESD/RA	0.9–7.3	0.11–0.83	1000/700	770 / 1.7
CESL823F/RA	CESL823F-ESD/RA	0.9–7.3	0.11–0.83	2000	
CESL824/RA	CESL824-ESD/RA	1.8–11.6	0.20–1.30	1000/700	
CESL824F/RA	CESL824F-ESD/RA	1.8–10.4	0.20–1.17	2000	
—	CESL827B-ESD/RA	6.0–18.2	0.68–2.06	1200/900	1050 / 2.3

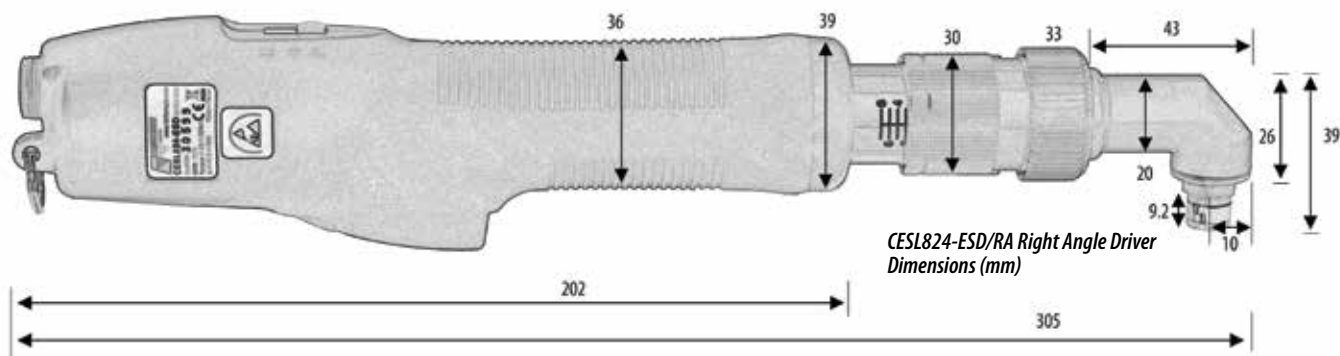

CESL824-ESD/RA Right Angle Driver Dimensions (mm)

32VDC CONTROLLERS & ACCESSORIES

The BECT620C/820(N) Controllers are specifically for use with CESL810-827 Brushless Tools. One controller (ordered separately) is required per screwdriver.

CE/RoHS/ETL Approved.



BECT820(N)
CONTROLLER

Model Number*	Outlets	Speeds	Tool Connector	Input	Output	Dimensions L x W x H (mm)	Weight kg / lbs	Use only with Screwdriver Models
BECT620C	1	Hi/Lo	6 pin	100-240VAC, 2.0A	32/24VDC	145 x 60 x 35	0.25 / 0.6	All 32VDC drivers except CESL823-824(P)F, CESL827B(P)-ESD
BECT820(N)				100-240VAC, 1.2A	32/24VDC	195 x 76 x 56	0.45 / 1.0	All 32VDC drivers

*Part number with North American cordset — Add suffix 'E' for EU cord, or suffix 'UK' for UK cord.

Accessories	Select driver model number on the right, follow column down the chart; X signifies an appropriate accessory.								
	CESL810(S)	CESL811	CESL812	CESL823(F)	CESL824(F)	CESL823P(F)	CESL824P(F)	CESL827B-ESD	CESL827BP-ESD
Torque Lock Sleeve — covers torque adjusting nut to deter tampering (1 included), metal lock sleeves also available (replace 'C' with 'E' in model number for ESD-safe version, or replace with 'M' for metal version)									
DR80-20133C (Clear, Non-ESD)	X	X	X						
DR80-10134C (Clear, Non-ESD)				X	X	X	X		
DR80-10131E (ESD-Safe)								X	X
Pistol Grip Attachment — reconfigures an in-line screwdriver for horizontal fastener installation (add 'ESD' to end of model number for ESD-safe version)									
DR80-PG823/4				X	X				
DR80-PG823/4P						X	X		
Tool Holster — fasten to the edge of a workbench and park the screwdriver when not in use									
DR80-10136 (w/ lock sleeve)				X	X	X	X	X	X
DR80-20136 (no lock sleeve)				X	X	X	X		
DR80-20141	X	X	X						



DR80-PG828/9



DR80-10136



Standard

Shielded

32VDC Cable Model	Length	Pins	Shielded?	Other Notes
DR96-66002M	2m (6.5')	6	no	included with each driver
DR96-66003M	3m (9.8')	6	no	—
DR96-66003M/C	3m (9.8')	6	no	coiled cable with 0.4m whip ends
DR96-66006M	6m (19.6')	6	no	—
DR96-832X3MSHA	3m (9.8')	6	yes	included with BECT832(N)-SSO-V4.0, ECT8-SSOA
DR96-832X5MSHA	5m (16')	6	yes	—
DR96-832X10MSHA	10m (32')	6	yes	—

CESL8 40VDC BRUSHLESS SCREWDRIVERS

8.9–43.4 in-lbs (0.98–4.90 Nm)

Delta Regis 40VDC Premium Brushless Screwdrivers pack the performance to satisfy demanding assembly applications. With brushless motor technology that withstands higher duty cycles, these drivers are ready to perform on production lines typically dependent on pneumatic tools. As with all Delta Regis Shut-off Clutch Screwdrivers, excellent torque repeatability is the fundamental building block that defines these models. A host of screwdriver configurations, accessories and control options are available to make the 40VDC Series an ideal choice for production assembly across a wide range of industries. Fast versions of some screwdrivers are available to speed up production lines that require installation of long fasteners.

- Clean, powerful 40V brushless motor technology
- 1/4" hex drive
- High speed versions available
- Dependable, long lifespan
- Lever and push start versions available, forward/reverse switch
- Optional ESD-safe housing available
- CE/RoHS compliant

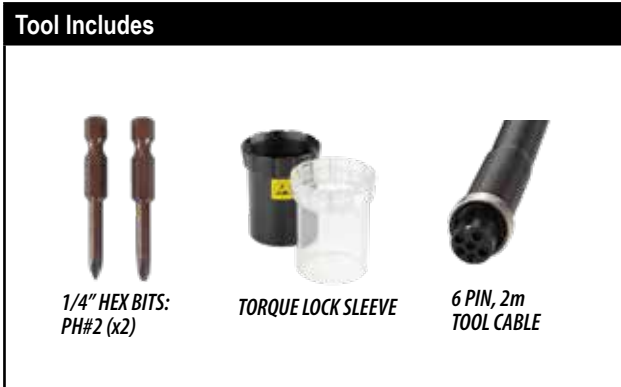

Model Number*	Start Type	Torque Range		Speed (rpm)	Drive Type	Length mm / in	Diameter mm / in	Weight kg / lbs
		in-lbs	Nm					
CESL828S	Lever	8.9–26.0	0.98–2.94	350	1/4" hex	278	39.5	0.8 / 1.76
CESL828PS	Push			1000				
CESL828	Lever			2000				
CESL828P	Push							
CESL828F	Lever							
CESL828PF	Push							
CESL829S	Lever	17.4–43.4	1.96–4.90	350				
CESL829PS	Push			1000				
CESL829	Lever							
CESL829P	Push							

*ESD-safe housing available — add suffix '-ESD'



7370 Commercial Circle, Fort Pierce, FL 34951
 ☎ 772.465.4302

www.deltaregis.com
 sales@deltaregis.com

CESLT9 40VDC BRUSHLESS SCREWDRIVERS

Delta Regis CESL9 Series Screwdrivers are engineered to perform in tough applications. The slim design and threaded metal front end make it an ideal choice for fixture mount and auto-screwfeed applications. A powerful motor and integrated fan keep the driver running cooler, particularly on soft joint and higher cycle applications.

40VDC Series drivers are capable of developing high torques. These drivers must be used with the included side handle attachment or mounted in a torque reaction arm for operator safety.

- Clean, powerful 40V brushless motor technology
- Integrated fan keeps the driver running cooler
- 1/4" hex drive
- High speed versions available
- Dependable, long lifespan
- Lever and push start versions available, forward/reverse switch
- Threaded metal front end ideal of fixture mounting
- Ideal for integrating into blow feed applications
- Optional ESD-safe housing available
- CE/RoHS compliant

18-106 in-lbs (2-12 Nm)

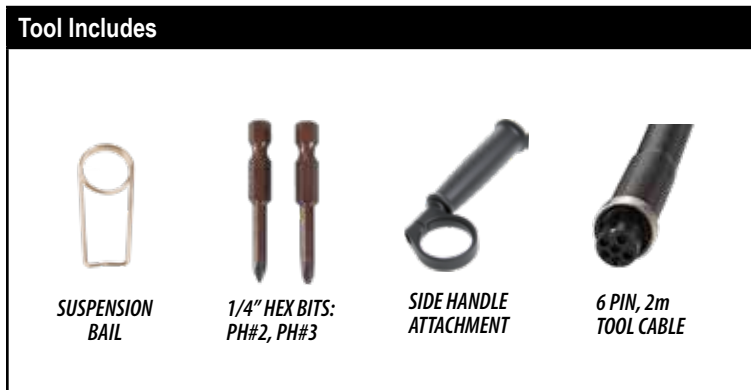

Model Number*	Start Type	Torque Range		Speed (rpm)	Drive Type	Length mm / in	Diameter mm / in	Weight kg / lbs
		in-lbs	Nm					
CESLT935	Lever	18-53	2-6	1000	1/4" hex	306 / 12	41.4 / 1.6	1.03 / 2.3
CESLT935P	Push							
CESLT935F	Lever			2200				
CESLT935PF	Push							
CESLT945	Lever	27-79	3-9	1000				
CESLT945P	Push							
CESLT955	Lever	53-106	6-12	880				
CESLT955P	Push							

*ESD-safe housing available — add suffix '-ESD'

HIGH TORQUE PREMIUM BRUSHLESS, SHUT-OFF CLUTCH

18-443 in-lbs (2-50 Nm)

CESLT8_M Series Screwdrivers incorporate an aluminum front collar to facilitate fixture mounting and each driver includes an accessory side handle for handheld applications (Excludes CESLT885/895(P)M Models).

40VDC Series drivers are capable of developing high torques. These drivers must be used with the included side handle attachment or mounted in a torque reaction arm for operator safety.

- Clean, powerful 40V brushless motor technology
- 1/4" hex drive
- Dependable, long lifespan
- Lever and push start versions available, forward/reverse switch
- Optional ESD-safe housing available
- CE/RoHS compliant



Tool Includes



SUSPENSION
BAIL



1/4" HEX BITS:
PH#3 (x2)



SIDE HANDLE
ATTACHMENT
(Excludes CESLT885/895(P)M Models)



6 PIN, 2m
TOOL CABLE

3/8" SQUARE DRIVE
ADD SUFFIX '-SQ'

Model Number*	Start Type	Torque Range		Speed (rpm)	Drive Type	Length mm / in	Diameter mm / in	Weight kg / lbs
		in-lbs	Nm					
CESLT835M	Lever	18-53	2-6	1200	1/4" hex**	297 / 11.7	46.2 / 1.81	1.25 / 2.75
CESLT835PM	Push							
CESLT845M	Lever	27-79	3-9	900				
CESLT845PM	Push							
CESLT855M	Lever	36-106	4-12	600				
CESLT855PM	Push							
CESLT855FM	Lever			880				
CESLT855PFM	Push							
CESLT865M	Lever	53-159	6-18	370				
CESLT865PM	Push							
CESLT865FM	Lever			600				
CESLT865PFM	Push							
CESLT875M	Lever	71-221	8-25	370				
CESLT875PM	Push							
CESLT885M-SQ***	Lever	106-310	12-35	350	3/8" Square	393 / 15.5	52.7 / 2.07	2.2 / 4.85
CESLT885PM-SQ***	Push							
CESLT895M-SQ***	Lever	177-443	20-50	200	1/2" Square			
CESLT895PM-SQ***	Push							

*ESD-safe housing available — add suffix '-ESD'

**3/8" Square Drive Available — add suffix '-SQ'

***not intended for soft joint applications



7370 Commercial Circle, Fort Pierce, FL 34951

772.465.4302

www.deltaregis.com

sales@deltaregis.com

CESL(T)8 40VDC RIGHT ANGLE DRIVERS

The Delta Regis 40VDC 90° Right Angle Drivers have a low-profile angle head attachment for applications with limited clearance. The right angle design provides the operator with a long handle to react the torque. CE/RoHS compliant.

8.9–195 in-lbs (0.98–22 Nm)

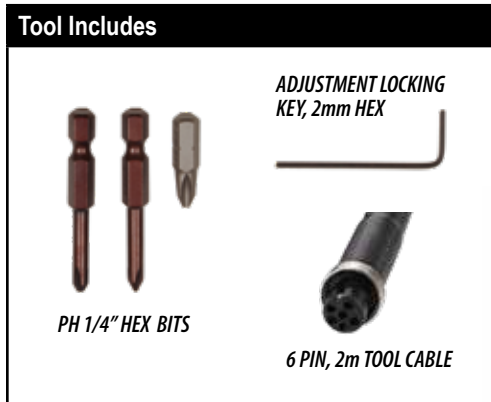

1/4" Hex Drive Models CESL828–829/RA, 0.98–3.61 Nm (8.9–32 in-lbs)

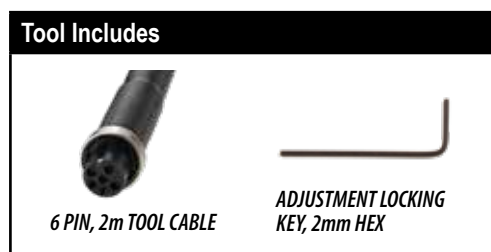
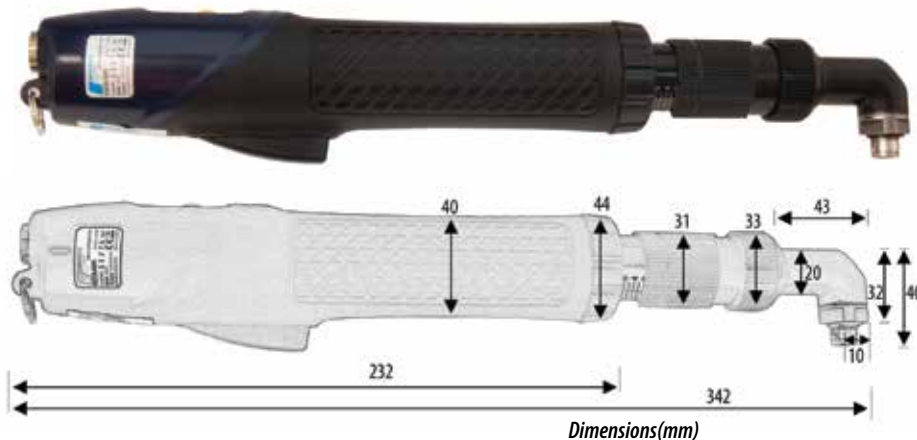

3/8" Sq. Drive Models CESLT835M–875M/RAS, 2–22 Nm (18–195 in-lbs)

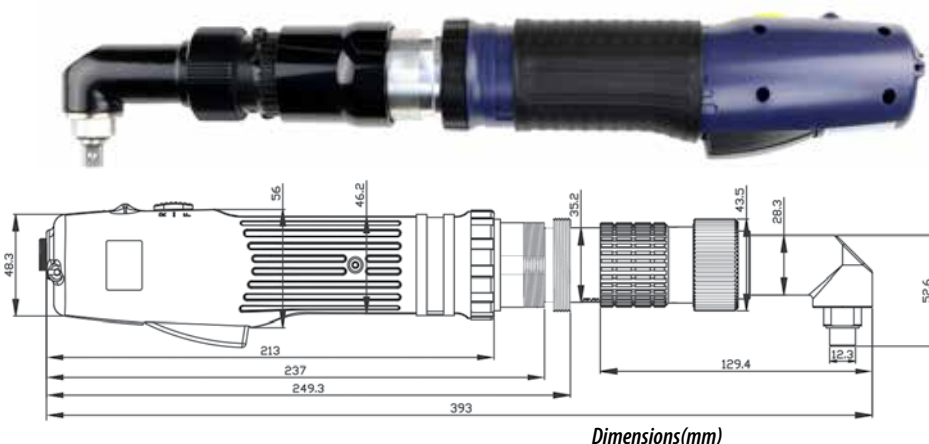

Model Number (Standard Housing)	Model Number (w/ ESD Housing)	Torque Range		Speed (rpm)	Drive Type	Weight kg / lbs
		in-lbs	Nm			
CESL828/RA	CESL828-ESD/RA	8.9–19	0.98–2.15	1000	1/4" hex	0.77 / 1.7
CESL828F/RA	CESL828F-ESD/RA	8.9–19	0.98–2.15	2000		
CESL829/RA	CESL829-ESD/RA	17.4–32	1.96–3.61	1000		
CESLT835M/RAS	CESLT835M-ESD/RAS	18–45	2–5	1200	3/8" square*	1.77 / 3.9
CESLT845M/RAS	CESLT845M-ESD/RAS	27–67	3–7.5	900		
CESLT855M/RAS	CESLT855M-ESD/RAS	53–90	6–10	600		
CESLT855FM/RAS	CESLT855FM-ESD/RAS	53–90	6–10	880		
CESLT865M/RAS	CESLT865M-ESD/RAS	71–145	8–15	370		
CESLT865FM/RAS	CESLT865FM-ESD/RAS	71–145	8–15	600		
CESLT875M/RAS	CESLT875M-ESD/RAS	106–195	12–22	370		

*1/4" hex available — Replace "RAS" suffix with "RAH"

CESPT8 SERIES 40V PISTOL GRIP SCREWDRIVERS

2.7–159 in-lbs (0.3–18 Nm)

- Clean, powerful 40V brushless motor technology
- 1/4" hex drive
- Fan-cooled motor reduces heat build-up
- Dependable, long lifespan
- Two speed selections available
- Trigger start, forward/reverse switch
- Compact, ergonomic pistol housing
- Available with top or bottom cable connection
- Optional ESD-safe housing available
- CE/RoHS compliant



Tool Includes



Model Number*	Torque Range		Speed (RPM)	Screw Diameter (mm)		Size (L x H)	Weight
	in-lbs	Nm		Machine	Tapping		
CESPT824	2.7–17.7	0.3–2	1200	2.3–3.5	2.3–3.0	185 x 150 mm (7.3 x 5.9")	0.7 kg (1.5 lbs)
CESPT828	7.1–26.5	0.8–3	1200	2.6–4.0	2.6–3.5		
CESPT828XF	8.8–26.5	1–3	3300				
CESPT829LT	10.6–31.0	1.2–3.5	1700	4.0–5.0	≤4		
CESPT829	17.7–44.3	2–5	700				
CESPT829F			1000				
CESPT830	22.1–62.0	2.5–7	850	5.0–6.0	≤5		

*Standard model has cable connection in bottom of handle — for top connection, add suffix 'U'. For ESD-safe housing, add suffix '-ESD'.



Tool Includes



Model Number*	Torque Range		Speed (rpm)	Drive Type**	Size (L x H x dia)	Weight
	in-lbs	Nm				
CESP(T)835	18–53	2–6	1000	1/4" hex	270 x 169 x 48 mm (10.6 x 6.7 x 1.9")	1.2 kg (2.64 lbs)
CESP(T)845	27–79	3–9	800			
CESP(T)855	36–106	4–12	550			
CESP(T)865	53–159	6–18	350			

*Standard model has cable connection in bottom of handle — for top connection, add suffix 'U'. For ESD-safe housing, add suffix '-ESD'.

**3/8" Square Drive available — add suffix '-SQ'



7370 Commercial Circle, Fort Pierce, FL 34951
772.465.4302

www.deltaregis.com
sales@deltaregis.com

40VDC BRUSHLESS CONTROLLERS & ACCESSORIES

There are two standard Hi/Lo Speed Controllers available for the 40VDC Brushless Drivers. The BECT640(N)HL is used primarily for screwdriver models CESL828-829(P)(F). The high power output model BECT940(N)HL is used for the higher torque 40VDC tools.

CE/RoHS/ETL Approved.

BECT640(N)HL
HI/LO SPEED CONTROLLER



Model Number*	Outlets	Speeds	Tool Connector	Input	Output	Dimensions L x W x H (mm)	Weight kg / lbs	Use only with Screwdriver Models
BECT640(N)HL	1	Hi/Lo	6 pin	100–240VAC, 6.3A	40/30VDC, 220W	220 x 134 x 85	1.8 / 4	CESL828–829(P)(F), CESPT824–829(F) (Excluding CESPT828F)
BECT940(N)HL					40/30VDC, 360W			CESLT835–875M(PM) CESP835–865, CESLT9

*Part number with North American cordset — Add suffix 'E' for EU cord, or suffix 'UK' for UK cord.

Accessories	CESL828(F) CESL829		CESL828(P)(F) CESL829P		CESL828(F)-ESD CESL829-ESD		CESL828(P)(F)-ESD CESL829P-ESD		CESLT935–955(P)(F)	CESLT835–875(P)M	CESP(T)835–865	CESPT824–829(F)
	Select driver model number on the right, follow column down the chart; X signifies an appropriate accessory.											
Torque Lock Sleeve — covers the torque adjusting nut to deter tampering (*1 included with applicable drivers)												
DR80-20142C (Clear) *	X	X										
DR80-20142E (ESD-safe) *					X	X						
DR80-20142M (Metal)	X	X	X	X					X			
DR80-20230M/L (Metal)												
DR80-20228M (Metal) *										X		
DR80-20229M (Metal)											X	
DR80-20233M (Metal) *												X
Pistol Grip Attachment — reconfigures an in-line screwdriver for horizontal fastener installation (add 'ESD' to end of model number for ESD-safe version)												
DR80-PG828/9	X		X	X								
DR80-PG828/9P			X	X								
Tool Holster — fasten to the edge of a workbench and park the screwdriver when not in use												
DR80-10136	X	X	X	X								
DR80-TH8-9	X	X	X	X	X							
DR80-TH8M										X	X	X



40VDC Cable Model	Length	Pins	Shielded?	Other Notes
DR96-10016M	2m (6.5')	6	no	included with each driver
DR96-10018M	3m (9.8')	6	no	—
DR96-10018M/C	3m (9.8')	6	no	coiled cable with 0.4m whip ends
DR96-10020M	6m (19.6')	6	no	—
DR96-840X3MSHA	3m (9.8')	6	yes	included with BECT840(N)/940(N)-SSO-V4.0, ECT8-SSOB
DR96-840X5MSHA	5m (16')	6	yes	—
DR96-840X10MSHA	10m (32')	6	yes	—

COUNTING CONTROLLER: 40V/32V BRUSHLESS DRIVERS

Add error-proofing to your Delta Regis brushless driver with the BECT832(N)/840(N)/940(N)-SSO-V4.0 Counting Controller. Available functions include Slow Start, Batch Counting, and OK/NG Rundown Indication based on the screwdriving cycle occurring within a predefined time window. An I/O terminal strip provides the interface to outputs for rundown OK, rundown NG, and batch complete. External switches can be wired to the input terminals for remote screwdriver enable/disable, remote start/reverse, and clear (reset batch count).

- Selectable **Slow Start** Speed and Time
- Large LED Display of Screw Count Values
- Externally Accessible **I/O Connections**
- **Programmable Batch Counting** with Audible Buzzer indicating batch complete
- **Programmable Time Window** for comparison with actual fastening cycle time — LEDs indicate **OK/NG** rundown cycle
- **Timed Auto-Reverse** function for applications requiring back-out after fastening
- Locks to limit access to program modifications
- ETL / CE / RoHS Compliant



Model Number*	Outlets	Speeds	Input	Output	Dimensions L x W x H (mm) / (in)	Weight kg / lbs	Applicable Driver Models
BECT832(N)-SSO-V4.0	1	Hi/Lo	100–240VAC, 1.2A	32/24VDC, 60W	200 x 130 x 100 / 7.9 x 5.1 x 3.9	1.6 / 3.5	CESL810–812, CESL823–824(P)(F), CESL827(P)
BECT840(N)-SSO-V4.0			100–240VAC, 6.3A	40/32/24VDC, 200W	248 x 130 x 100 / 9.8 x 5.1 x 3.9	2.5 / 5.5	CESL828–829(P)(F), CESPT824–829(F), (Excluding CESPT828F) all 32V CESL8 drivers**
BECT940(N)-SSO-V4.0				40/32/24VDC, 360W			all 32V and 40V brushless drivers**

*Power supply shipped with standard North American cordset. Add suffix 'E' for EU cord, or add suffix 'UK' for UK cord.

**DR96-40TO32V-WHIP cable required to connect 32V drivers with BECT840(N)-SSO-V4.0 or BECT940(N)-SSO-V4.0

Features	
Slow Start Time Adjustment	0–9.9 sec
Slow Start Speed Adjustment	30–100%
Count (per batch)	1–99
Time Window Setting Range (min/max)	0–9.9 sec
Audible Alert (selectable)	Good/NG/Batch OK
Timed Auto-Reverse after Clutch-out	0–9.9 sec

Inputs (dry switch contact required)	Outputs (MOS relay, max. 40VDC, 250mA)
1. Remote Start	1. Rundown OK
2. Remote Reverse	2. Rundown NG
3. Disable Screwdriver	3. Batch Complete
4. External Confirm	A 24 VDC voltage supply is available to power the output circuit, if required.
5. Enable at Batch Start	
6. Remote Clear	



7370 Commercial Circle, Fort Pierce, FL 34951

772.465.4302

www.deltaregis.com

sales@deltaregis.com

COUNTING CONTROLLER OVERVIEW

Parameters are set-up on the BECT(832(N)/840(N)/940(N))-SSO-V4.0 using the four button keypad and LED display panel. A simple program loop provides access to settings for slow start speed and time, batch count quantity, and min/max allowable rundown times. During normal operation, the large two-digit display shows the current screw count value and also provides visual LED indication of whether the rundown was Good or No Good based on the time window parameters that have been programmed into the controller.

BECT(832(N)/840(N)/940(N))-SSO-V4.1 CONTROLLER WITH REMOTE SEQUENCING OPTION

In some applications, there may be a requirement to remotely select from one of the available sequences that have been programmed into the controller. The 'V4.1' model number suffix replaces the standard remote start/reverse inputs with a remote sequence selection input option. With this option, one of 3 sequences may be selected by providing a remote input from a PLC or external switches. Please contact us for further details.



*If the fastening cycle completes (clutch trips) within the programmed time window, the rundown cycle will be accepted as GOOD (OK) and the batch count will increment. A rundown outside the time parameters will result in a NG output.



BESL3 SERIES 120VAC DIRECT PLUG-IN SCREWDRIVERS

1.33–43.4 in-lbs (0.15–4.9 Nm)

- Clean, brushless motor technology
- Dependable, long lifespan
- Outperforms brush-type drivers
- Plugs directly into 115VAC receptacle
- Input 110–120VAC, 50/60Hz, 48W
- Integral 3m power cord w/ US plug
- Lever or push start models available
- Right angle versions available



Tool Includes



TORQUE LOCK SLEEVE

SUSPENSION BAIL

1/4" HEX BITS:
BESL300–301: PH#1, #2
BESL302: PH#2 (x2)

Model Number	Start Type	Torque Range		Speed (rpm)	Length in / mm	Diameter in / mm	Weight lbs / g
		in-lbs	Nm				
BESL300	Lever	1.33–10.44	0.15–1.18	1200	9.6 / 245	1.4 / 36	1.0 / 470
BESL300P	Push	1.77–10.44	0.2–1.18	1200			
BESL300F	Lever	1.33–10.44	0.15–1.18	2000			
BESL300PF	Push	1.77–10.44	0.2–1.18	2000			
BESL301	Lever	3.47–19.12	0.39–2.16	1200			
BESL301P	Push	3.47–19.12	0.39–2.16	1200			
BESL301F	Lever	2.57–14.78	0.29–1.67	2000			
BESL301PF	Push	2.57–14.78	0.29–1.67	2000			
BESL302LT	Lever	4.34–21.7	0.49–2.45	1000	11.0 / 280	1.5 / 38	1.6 / 740
BESL302PLT	Push	4.34–21.7	0.49–2.45	1000			
BESL302FLT	Lever	4.34–21.7	0.49–2.45	2000			
BESL302PFLT	Push	4.34–21.7	0.49–2.45	2000			
BESL302	Lever	17.4–43.4	1.96–4.9	1000			
BESL302P	Push	17.4–43.4	1.96–4.9	1000			

Right Angle Model Number	Start Type	Torque Range		Speed (rpm)	Length in / mm	Diameter in / mm	Weight lbs / g
		in-lbs	Nm				
BESL300-RA	Lever	1.06–8.35	0.12–0.94	1200	11.4 / 290	1.4 / 36	1.6 / 720
BESL300F-RA		1.06–8.35	0.12–0.94	2000			
BESL301-RA		2.77–15.30	0.31–1.73	1200			
BESL301F-RA		2.06–11.82	0.23–1.34	2000	13.3 / 337	1.5 / 38	2.2 / 990
BESL302LT-RA		3.0–15.2	0.34–1.71	1000			
BESL302FLT-RA		3.0–15.2	0.34–1.71	2000			
BESL302-RA		12.2–30.4	1.37–3.43	1000			



7370 Commercial Circle, Fort Pierce, FL 34951
772.465.4302

www.deltaregis.com
sales@deltaregis.com

ECT8-SSO SLOW START & I/O MODULE

ECT8-SSOA / ECT8-SSOB Advanced Multi-Function Input/Output Modules

Delta Regis ECT8-SSO Series Control Modules are ideal for processes that require more functionality than is provided by the standard hi/lo speed controller. The module installs in-line between the controller and the driver. It has a whip cable which plugs into the controller, and a 6 pin connector to accept the screwdriver cable. An LED display and programming buttons are provided for set-up of slow start parameters. I/O connections are available for interfacing to external equipment.



Push buttons and LED display for setting slow start parameters. Indicator lights show status of input / output signals.

SLOW START PARAMETERS

- Slow Start Time (0–9.9s)
- Slow Start Speed (~30–100%)
- Max Run Time (0–9.9s)



ECT8-SSO Module plugs in-line between a CESL8/9 Series Driver and a standard 32V or 40VDC Hi/Lo Speed Controller.

A 3m long shielded tool cable is included with each ECT8-SSOA/B module to use in place of the standard unshielded cable included with the driver.



INPUTS (dry switch contact required)

- Remote Start
- Remote Reverse
- Remote Enable/Disable

OUTPUTS (MOS relay, max. 40VDC, 250mA)

- Tool Started/Running
- Clutch Tripped
- Tool in Reverse



Bypass switch to disable control functionality



DIP switch settings control specific I/O functions

Model Number	Use with Screwdriver Models	Compatible Controllers	Dimensions (L x W x H)	Weight
ECT8-SSOA (32V Tools)	CESL810–812, 823–827(P/F/PF)	BECT620C, BECT820(N)	103 x 100 x 32 mm / 4.1 x 3.9 x 1.3"	180 g / 0.4 lbs
ECT8-SSOB (40V Tools)	CESL828–829(P)(F), CESP(T)835–865, CESLT835–875(P)M, CESLT935–955(P)(F)	BECT640(N)HL, BECT940(N)HL		

ECT8-SSOC / ECT8-SSOD Basic Modules with Slow Start & Output Signals

Basic modules are available for applications requiring only slow start and/or output signals that can be interfaced with external equipment. The slow start function offers the same adjustments as the advanced module shown above. The output signals (tool running/clutch activated/tool in reverse) are via dry relay contacts (40VDC, 250mA max).

Model Number	Use with Screwdriver Models	Compatible Controllers
ECT8-SSOC (32V Tools)	CESL810–812, 823–827(P/F/PF)	BECT620C, BECT820(N)
ECT8-SSOD (40V Tools)	CESL828–829(P/F/PF), CESP(T)835–865, CESLT835–875(P)M, CESLT9	BECT640(N)HL, BECT940(N)HL

SCREW FEEDERS FOR MANUAL PICKUP

- Improve productivity — screw dispensed for easy pick-up
- Magnetic pick-up of ferrous screws
- Precise vibration control allows feeding of many different screw types and sizes
- Adjustable drum rotation timer, vibration timer, and vibration intensity
- Individual driver motors for vibration and feeding
- Auto shut-off of vibration/feed when not in use
- Quiet operation
- Simple service and set-up
- Great value — very cost effective way to increase productivity
- Small size — does not clutter work space
- Includes AC adapter, set-up tools and shims

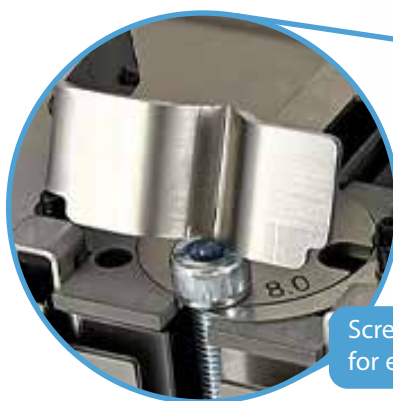

Screwdriver bit guide for easy engagement



Model	Dimensions (L x W x H)	Weight (w/o adapter)	Power Source	AC Adapter	Applicable Screw	Max Screw Thread Length
DRFF-520SS	182 x 126 x 147 mm	2.49kg / 5.5lbs	100–240VAC	15VDC	M1.0–M5.0 (Adjustable)	20 mm
DRFF-208*	160 x 82 x 112 mm	1.53kg / 3.3lbs	100–240VAC	12VDC	M0.8 / M1.0 / M1.2 / M1.4 / M1.7 / M2.0	8 mm
DRFF-508*	182 x 124 x 150 mm	3.1kg / 6.8lbs			M0.8 / M1.0 / M1.2 / M1.4 / M1.7 / M2.0 / M2.3 / M2.6 / M3.0 / M3.5 / M4.0 / M5.0	8 mm
DRFF-519*	182 x 124 x 150 mm	3.1kg / 6.8lbs			M1.2 / M1.4 / M1.7 / M2.0 / M2.3 / M2.6 / M3.0 / M3.5 / M4.0 / M5.0	19 mm
DRFF-519E* (Extended Rail)	216 x 126 x 150 mm	3.1kg / 6.8lbs			M1.2 / M1.4 / M1.7 / M2.0 / M2.3 / M2.6 / M3.0 / M3.5 / M4.0 / M5.0	19 mm
DRFF-530* (600cc Hopper)	249.5 x 162.5 x 175 mm	5 kg / 11.0 lbs			M2.0 / M2.3 / M2.6 / M3.0 / M3.5 / M4.0 / M5.0 / M6.0	30 mm
DRFF-535*	292.5 x 190 x 210 mm	7 kg / 15.4 lbs			M2.0 / M2.3 / M2.6 / M3.0 / M3.5 / M4.0 / M5.0 / M6.0 / M8.0 / M9.0	35 mm

*To order, add screw size to model number as a suffix (eg.— for a DRFF-519 with M1.4 screws specify 'DRFF-519-1.4')

SCREW FEEDERS FOR VACUUM PICKUP & AUTOMATION

- Ideal for robotic applications — magnetic or vacuum pick-up
- Signal output when screw is ready for pick-up/PLC counting
- Brushless driver motors for vibration and feeding
- Quiet operation
- Simple service and set-up
- Integrated screw counter with LED displays for assembly process feedback
- Small size — does not clutter work space
- Includes AC adapter, set-up tools and shims

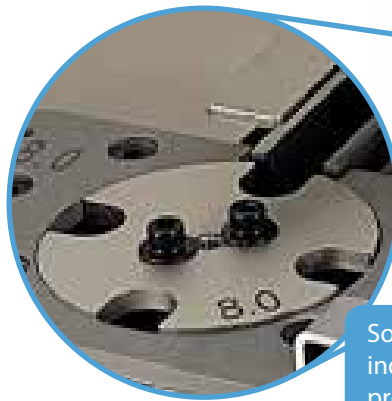

Solid turntable splits out individual fasteners for precise robotic pick-up



Model*	Dimensions (L x W x H)	Weight (w/o adapter)	Power Source	AC Adapter	Applicable Screw (Specify size when ordering)	Max Screw Thread Length
DRFF-208R*	160 x 82 x 112 mm	1.46kg / 3.2lbs	100–240VAC	12VDC	M0.8 / M1.0 / M1.2 / M1.4 / M1.7 / M2.0	8 mm
DRFF-508R	182 x 124 x 150 mm	3.1kg / 6.8lbs			M0.8 / M1.0 / M1.2 / M1.4 / M1.7 / M2.0 / M2.3 / M2.6 / M3.0 / M3.5 / M4.0 / M5.0	8 mm
DRFF-519R*	182 x 124 x 150 mm	3.1kg / 6.8lbs			M1.2 / M1.4 / M1.7 / M2.0 / M2.3 / M2.6 / M3.0 / M3.5 / M4.0 / M5.0	19 mm
DRFF-519RE* (Extended Rail)	216 x 126 x 150 mm	3.1kg / 6.8lbs			M1.2 / M1.4 / M1.7 / M2.0 / M2.3 / M2.6 / M3.0 / M3.5 / M4.0 / M5.0	19 mm
DRFF-530R* (600cc Hopper)	249.5 x 162.5 x 175 mm	5 kg / 11.0 lbs			M2.0 / M2.3 / M2.6 / M3.0 / M3.5 / M4.0 / M5.0 / M6.0	30 mm
DRFF-535R*	292.5 x 190 x 210 mm	7 kg / 15.4 lbs			M2.0 / M2.3 / M2.6 / M3.0 / M3.5 / M4.0 / M5.0 / M6.0 / M8.0 / M9.0	35 mm

*To order, add screw size to the model number as a suffix (eg.— for a DRFF-208R with M1.4 screws specify 'DRFF-208R-1.4')

SCREW COUNTERS

- Turntable mechanism for accurate screw counting
- Dispenses up to 2 fasteners per second
- Digital display for monitoring counting status and programming functions
- Max 99 fasteners per batch
- High quality brushless motors
- Large 600cc (36.6 ci) capacity hopper
- Includes: AC adapter, grounding wires & setup tools



Clear top and front panels for easy troubleshooting

Model*	Dimensions (L x W x H)	Weight (w/o adapter)	Power Source	AC Adapter	Applicable Screw (Specify size when ordering)	Max Screw Thread Length
DRFF-630C	308 x 162.5 x 202 mm	5 kg / 11 lbs	100–240VAC (50/60Hz)	12VDC (2.0A)	M2.0 / M2.3 / M2.6 / M3.0 / M3.5 / M4.0 / M5.0 / M6.0	30 mm
DRFF-835C	345 x 190 x 234 mm	7 kg / 15.5 lbs			M2.0 / M2.3 / M2.6 / M3.0 / M3.5 / M4.0 / M5.0 / M6.0 / M8.0 / M9.0	35 mm

*To order, add screw size to the model number as a suffix (eg.— for a DRFF-630C with M4.0 screws specify 'DRFF-630C-4.0')

BULK HOPPERS

- Pairs with all DRFF-530, DRFF-630 & DRFF-535 Series Screw Presenters
- Provides additional storage capacity and will automatically replenish fasteners in the primary screw presenter hopper based on fastener levels.
- I/O for external control
- High quality brushless motors
- Multiple programming options to provide optimal feeding for different fastener types
- Includes: AC adapter, primary hopper sensor



Model*	Dimensions (L x W x H)	Weight (w/o adapter)	Power Source	AC Adapter	Bulk Hopper Capacity	Compatible DRFF Series Screw Presenter
DRFF-800HP	175 x 163 x 232 mm	3.0 kg / 6.6 lbs	100–240VAC (50/60Hz)	12VDC (2.0A)	800CC	DRFF-530(R), DRFF-630C
DRFF-1500HP	202 x 190 x 320 mm	5.0 kg / 11.02 lbs			1500CC	DRFF-535

DRTQ TOUCH-SCREEN TORQUE TESTER



Specifications

Models (max torque)	10 in-lbs, 25 in-lbs, 100 in-lbs, 250 in-lbs, 100 ft-lbs
Accuracy	± 0.5% of reading @ 20–100% full scale ±1% of reading @ 10–20% full scale
Maximum Overload	150% of full scale
Battery	3.7V Li-ion, 4400mAH 8 hrs continuous runtime
AC Adapter / Charger	Input: 100–240 VAC, 50/60 Hz Output: 5 VDC, center positive
Dimensions (L x W x H)	229 x 102 x 80 mm 9 x 4 x 3.13 in
Weight	2.7 kg / 6 lbs
Included with each tester	AC Adapter, Carrying Case, User Manual, Calibration Certificate, Rundown Joint*

*Rundown joint is not included with DRTQ-100-f, sold separately



- CE Compliant
- Full color LCD touch screen
- Processes statistical calculations: CP, CPK, Sigma
- On screen statistics: Torque calculator and graphing for performance analysis
- Export data directly to an SD card
- Automatic screen rotation (level sensor flips screen between vertical and horizontal mode)
- 'Quick Run' mode provides the ability to quickly audit and verify a tool
- 'Measure Mode' allows users to establish acceptable tolerances — eight configurable torque test profiles available
- Eight available measurement units: in-oz, in-lbs, ft-lbs, Nm, cNm, Kgf Cm, Gf Cm, Kgf m
- Li-ion technology provides extended battery life
- Battery saving features: Sleep Mode, Back Light Timer, Automatic Shutdown
- Peak mode: For use with manual, electric, pneumatic, and cordless torque controlled tools (not for use with impact tools)
- Track Mode: For use with dial or electronic torque wrenches
- Advanced user programmable options: Auto Clear, Date/Time, Peak Time, Screen Brightness
- 2 year warranty
- Made in North America



DRTQ TOUCH-SCREEN TORQUE TESTER



Configure up to 8 unique profiles to accommodate different test strategies.

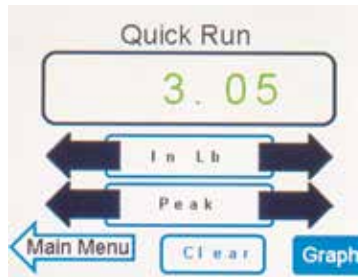

Use Quick Run mode to perform a single run torque test and view a graph of the results.



Resulting graph displays torque vs. time. Tap an area of the graph to zoom up to 4 times the size.



Use Measure Mode to evaluate a series of torque readings based on the profile parameter settings.

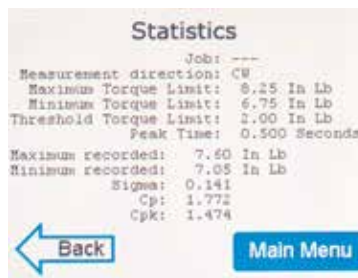

Statistics are calculated based on profile settings and evaluation of the sample group readings.

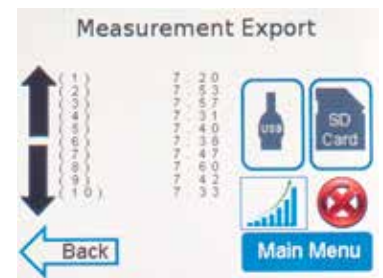

Sample group torque readings & statistics can be saved with a file name to an SD card for export.

DRTQ Torque Tester Models			
Model Number	Torque Range		Input Drive (female)
DRTQ-160-z	16.00–160.00 in-oz	0.11–1.13 Nm	1/4" square
DRTQ-10-i	1.00–10.00 in-lbs	0.11–1.13 Nm	1/4" square
DRTQ-25-i	2.50–25.00 in-lbs	0.28–2.82 Nm	1/4" square
DRTQ-100-i	10.00–100.00 in-lbs	1.13–11.30 Nm	1/4" square
DRTQ-250-i	25.00–250.00 in-lbs	2.82–28.25 Nm	3/8" square
DRTQ-100-f	10.00–100.00 ft-lbs	13.56–135.58 Nm	1/2" square

Each DRTQ Torque Tester is dead-weight calibrated with certified mass standards and arms to verify conformance to the stated accuracy of $\pm 0.5\%$ of indicated value (from 20–100% of full scale). A calibration certificate is included with each tester.

DRTQ Accessories	
Part Number	Description
DRTQ-MOUNT-HT	Reaction collar for bench mounting
DRTQ-RDA-1/4*	1/4" sq.dr. joint simulator
DRTQ-RDA-3/8	3/8" sq.dr. joint simulator (250 in-lbs / 28 Nm max)
DRTQ-RDA-1/2-100NM	1/2" sq.dr. joint simulator (74 ft-lbs / 100 Nm max)
DRTQ-ELEC3050	AC Adapter, 100–240VAC input / 5VDC output USB

*Add '-10i', '-25i', or '-100i' to end of model number to specify hardness of joint (as configured by default)



DRTQ-MOUNT-HT
Bench Mounted Reaction Collar
(Accepts all DRTQ Models)

TORQUE REACTION ARMS

ERGO Telescopic Torque Reaction Arm

The ERGO Telescopic Reaction Arm is used to absorb and transfer the reaction force generated at the screwdriver during fastening, without having a significant effect on freedom of movement, thereby reducing operator fatigue. Through the use of carbon-fiber tubes, the arm is extremely tough while being light at the same time. With the universal mounting adapter, the ERGO is capable of being mounted problem-free in most work areas.

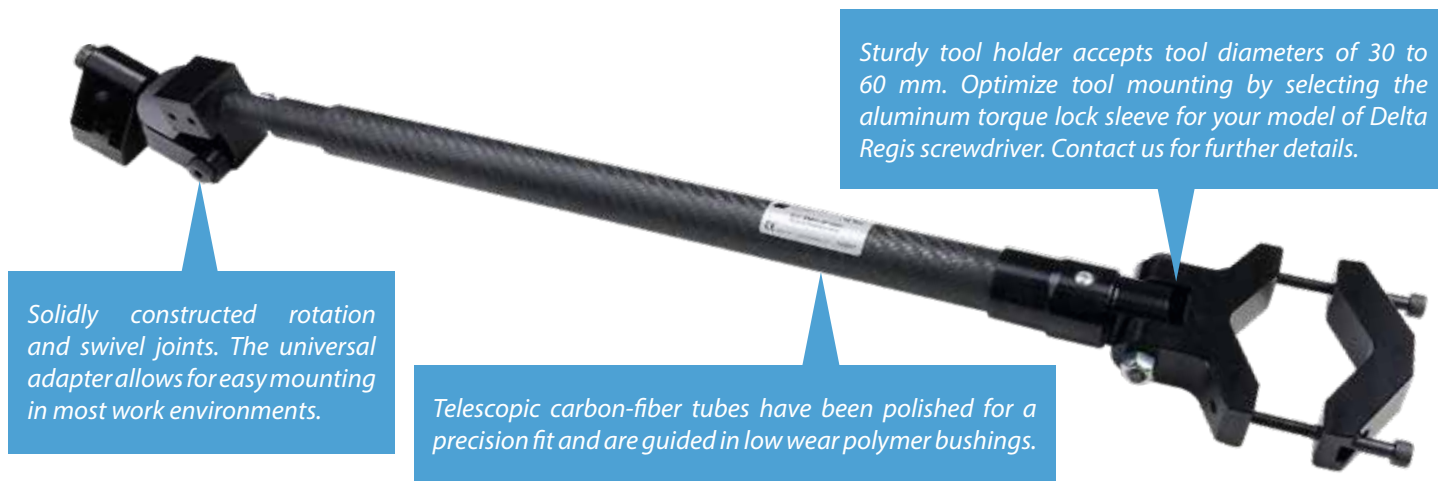

Model Number	Max. Torque	Work Radius	Fits Tool Diameter	Weight
ERGO-15-1000A	133 in-lbs / 15 Nm	486–1066 mm / 19.13–41.97"	27–45 mm / 1.06–1.77"	1.5 lbs / 0.69 kg
ERGO-40-1000A	354 in-lbs / 40 Nm	486–1066 mm / 19.13–41.97"	30–60 mm / 1.2–2.4"	2.5 lbs / 1.13 kg

DR90-20004 Economy Torque Reaction Arm

Reduce employee injury by absorbing torque transmission, eliminating repetitive strain on hands, wrists and arms. These arms are capable of supporting tools up to 5 lbs (2.27 kg) while withstanding torque reaction up to 240 in-lbs (27 Nm). Arm height is adjustable, and a parallel arm design keeps the tool perpendicular to the work surface. Tool weight is supported by a spring-loaded arm assembly with adjustable spring tension.

Two versions are available to suit either pneumatic tool or electric tool mounting. The DR90-20004P has a 1/4" npt threaded female port for mounting an in-line air tool vertically using a pipe nipple. The DR90-20004E includes an electric tool adapter to provide for clamping around the body of an electric screwdriver.



Part Number	Description
DR90-20004E	Torque Arm for Electric Screwdriver
DR90-20004P	Torque Arm for Pneumatic Driver
DR90-20002	Optional Bench Clamp

TOOL STAND AND BALANCERS

DR90-30001 Tool Stand

Using a tool balancer in conjunction with a tool stand will keep your screwdriver at the ready, leaving your work area clear when not in use. The DR90-30001 tool stand fastens directly to your workbench (screws required). An optional extra arm kit can be used to suspend two tools from the same stand.



Part Number	Description
DR90-30001	Tool Stand — 110 cm high, 60 cm reach, 2.3 kg (5 lbs) maximum load
DR90-3ARMKIT	Extra Arm Kit — 60 cm reach, includes slider and hanging clip
DR90-3CLAMP	Bench Clamp — Fastens stand to edge of workbench, no drilling required

Tool Balancers

A tool balancer mounted directly above the assembly area is an ideal way to prolong the service life of a power tool while keeping it readily available for use. Our spring-rewind balancers have adjustable retract force and a maximum vertical travel of 6 feet.



Part Number	Cable	Optimal Load Range	Travel Distance
DR90-10101	Steel	0.23–0.68 kg (0.5–1.5 lbs)	1.8m (6')
DR90-10103	Steel	0.68–1.36 kg (1.5–3.0 lbs)	1.8m (6')
DR90-10105	Steel	1.36–2.27 kg (3.0–5.0 lbs)	1.8m (6')
DR90-10104	Nylon	0.6–1.5 kg (1.3–3.3 lbs)	1.8m (6')

ERGO-SYS TOOL SUPPORT SYSTEM

For excellent tool support combined with tool torque reaction capability, choose the Delta Regis ERGO-SYS Tool Support System.

Each system includes:

- (1) DR90-30001 Tool Stand
- (1) ERGO-15-1000 Torque Reaction Arm
- (1) DR90-1010_ Tool Balancer

Select the system with the balancer that best suits the weight of the tool being supported. Optional metal lock sleeve and tool stand bench clamp can be purchased as separate accessories if required. Screwdriver not included.



Optional metal lock sleeves are available. Contact our sales department for further details.



System Number	Includes Balancer	Supports Tool Weight
ERGO-SYS-1	DR90-10101	0.5–1.0 lbs
ERGO-SYS-3	DR90-10103	1.0–2.5 lbs
ERGO-SYS-5	DR90-10105	2.5–4.5 lbs

ADJUSTABLE & PRESET MANUAL SCREWDRIVERS

- Adjustable in small increments — Set and lock at required torque
- Ergonomic handle provides better turning power with less effort, minimizing operator fatigue
- Quick change bit holder accommodates insert and power bits (1/4" Hex models)
- Accuracy is $\pm 6\%$ (complies with EN ISO 6789)
- Calibration certificate provided with each tool
- ESD-safe models identified by yellow grip and ESD symbol



Adjustable Screwdrivers						
Model	ESD-Safe Model	Style	Range	Graduations	Length (mm)	Drive
—	DR95-A1430-ESD	Straight	0.02–0.06 Nm	0.0025 Nm	141	4mm Halfmoon / 4mm Winged
—	DR95-A1431-ESD	Straight	0.05–0.11 Nm	0.005 Nm	141	
—	DR95-A7435-ESD	Straight	0.10–0.34 Nm	0.015 Nm	142	
—	DR95-A7436-ESD	Straight	0.30–1.00 Nm	0.05 Nm	142	
DR95-A7430	DR95-A7430-ESD	Straight	0.10–0.34 Nm	0.015 Nm	142	1/4" Hex
DR95-A7431	DR95-A7431-ESD	Straight	0.30–1.00 Nm	0.05 Nm	142	
DR95-A7432	DR95-A7432-ESD	Straight	0.90–1.50 Nm	0.05 Nm	142	
DR95-A7440	DR95-A7440-ESD	Straight	0.3–1.2 Nm	0.05 Nm	155	
DR95-A7441	DR95-A7441-ESD	Straight	1.2–3.0 Nm	0.10 Nm	155	
DR95-A7442	—	Pistol	3.0–6.0 Nm	0.25 Nm	150 x 100	
DR95-A7443	—	Pistol	4.0–8.8 Nm	0.40 Nm	150 x 100	
DR95-A7445	DR95-A7445-ESD	Straight	2.5–11.5 in-lbs	0.5 in-lbs	155	
DR95-A7446	DR95-A7446-ESD	Straight	11–29 in-lbs	1.0 in-lbs	155	
DR95-A7447	—	Pistol	25–55 in-lbs	2.5 in-lbs	150 x 100	



DR95-A7436-ESD

Preset Screwdrivers					
Model	ESD-Safe Model	Style	Range	Length (mm)	Drive
—	DR95-P1460-ESD	Straight	0.02–0.06 Nm	131	4mm Halfmoon / 4mm Winged
—	DR95-P1461-ESD	Straight	0.05–0.11 Nm	131	
—	DR95-P7455-ESD	Straight	0.1–0.34 Nm	138	
—	DR95-P7456-ESD	Straight	0.3–1.0 Nm	138	
DR95-P7450	DR95-P7450-ESD	Straight	0.1–0.34 Nm	133	1/4" Hex
DR95-P7451	DR95-P7451-ESD	Straight	0.3–1.0 Nm	133	
DR95-P7452	DR95-P7452-ESD	Straight	0.9–1.5 Nm	133	
DR95-P7460	DR95-P7460-ESD	Straight	0.3–1.2 Nm	155	
DR95-P7461	DR95-P7461-ESD	Straight	1.2–3.0 Nm	155	
DR95-P7462	—	Pistol	3.0–6.0 Nm	150 x 100	
DR95-P7463	—	Pistol	4.0–8.8 Nm	150 x 100	
DR95-P7465	—	Straight	2.5–11.5 in-lbs	155	
DR95-P7466	—	Straight	11–29 in-lbs	155	
DR95-P7467	—	Pistol	25–55 in-lbs	150 x 100	



DR95-P1460-ESD

SCREWDRIVER VACUUM PICK-UP ATTACHMENT

Vacuum Pickup Attachment With Driver Bits



Need to hold a non-ferrous fastener with the bit of your electric screwdriver? The Delta Regis Vacuum Pickup Attachment is a miniature, bit-mounted vacuum nozzle. The vacuum attachment is held on the screwdriver bit by a collet appropriately sized for the shank diameter of the bit. This allows for initial positioning of the pickup nozzle relative to the tip of the screwdriver bit. The nozzle tip is spring loaded and has a small amount of linear travel. The head of the screw seals up against the end of the nozzle and the nozzle rotates with the screw and driver bit. The outer collar of the attachment remains stationary and connects to a vacuum supply.

The vacuum pickup attachment is ordered as an assembly complete with the required screwdriver bit. The nozzle which seals the vacuum against the fastener rotates with the screw head and driver bit. The table below outlines options to specify a model number for the assembly.

Model #							Material Code	Nozzle Material
VACPU	H70PH1	30	A	M2				
						A	Aluminum	
						B	Brass	
						S	Stainless	

Code	Bit Type (1/4" Hex)	Bit Length (mm)	Replacement Bit Part #	Bit Tip Dia (mm)	Bit Shank Dia (mm)	Collet Dia Code
H70PHX	PH #00	70	DR91-1202XRD-A	2	3	30
H70PH0	PH #0	70	DR91-12020RD-A	2.5	3	30
H70PH1	PH #1	70	DR91-12021RD-A	2.5	3	30
H70PH2	PH #2	70	DR91-12022RD-A	3	4	40
H70TX5	TX5	70	DR91-135171	3	3	30
H70TX6	TX6	70	DR91-134740	3	3	30
H70TX8	TX8	70	DR91-060098	3	3	30
H70TX10	TX10	70	DR91-060100	4	4	40
H70TX15	TX15	70	DR91-060105	4	4	40
H89IP6	6IP	89	DR91-134667	3	3	30
H89IP8	8IP	89	DR91-134670	3	3	30
H89IP9	9IP	89	DR91-134669	3	3	30
H70IP10	10IP	70	DR91-134684	4	4	40
H70IP15	15IP	70	DR91-134686	4	4	40

Nozzle Code	Length (mm)	OD (mm)	ID (mm)
'M' Nozzles require min. 70mm bit length			
M0	10	6.4	3.2
M1	10	6.4	4
M2	10	6.4	4.5
M3	10	8	5
M4	10	8	6.4

Select a nozzle with an ID at least 1mm larger than the bit tip diameter. Nozzle ID must be smaller than the screw head OD.

Please note that the bit types and nozzle configurations shown cover the most common applications. Please contact us for information on other bit types or special nozzle configurations.

Vacuum Pump (Pneumatic)

The DR80-VACPUMP acts as a vacuum source for the VACPU assembly. The vacuum generator operates on a compressed air supply and includes an ON/OFF slide valve and a pressure regulator to adjust the vacuum flow. 2.5m (8 ft) of 6mm OD tubing is included to connect the VACPUMP to the fitting on the vacuum pickup attachment.



Air Supply requirements: 1 SCFM, 45-90 psig, 1/4" npt inlet port

Driver Bits & Bit Holders

Delta Regis offers a comprehensive selection of Screwdriver Bits, Nutsetters, and Bit Holders. Due to the extensive range of product, we have chosen to maintain an updated PDF list of available accessory bits on our website.

We offer bits in standard 1/4" hex drive for screws with Phillips, Slot, Torx, Square and Socket heads. A limited selection of bits with 4mm and 5mm round shank (winged) drive are also available. Magnetic and non-magnetic Nutsetters and Bit Holders of various lengths and configurations are available to suit specific application requirements. Minimum purchase quantities may apply, depending on the item.

Please give us a call or send us an e-mail if you require an accessory item that you don't see listed on our website or in our catalog. We'll be glad to try and assist you in getting the proper accessory to use with your Delta Regis screwdriver.



Contact us

Delta Regis Canada Inc.
790 Redwood Sq. Unit 10-11
Oakville, ON L6L 6N3
Canada

Ph 1.888.500.2755 or 905-847-4440
Fx 1.866.500.7270 or 905-847-9907

Delta Regis Tools Inc.
7370 Commercial Circle
Fort Pierce, FL 34951
USA

Ph 1.888.500.2755 or 772.465.4302
Fx 1.866.500.7270 or 772.465.4368

www.deltaregis.com
sales@deltaregis.com



deltaregis.com

Cat# DRUS1023